

### 1.7m<sup>3</sup> Bin Dimensions

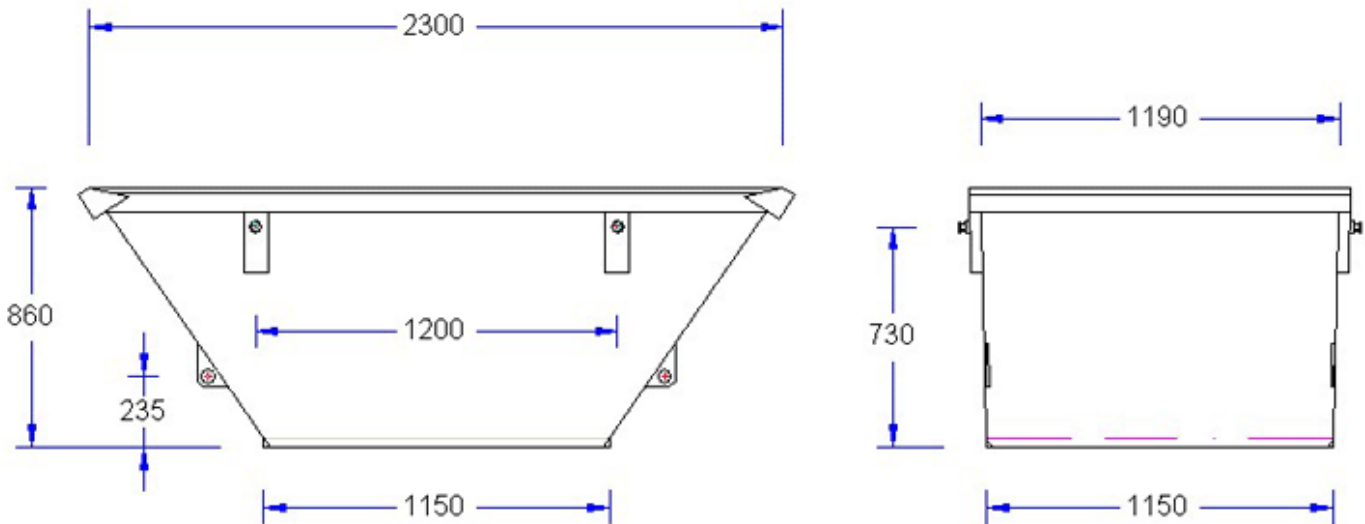

The mini skips are ideal for use in the domestic market for garden cleanups, small building projects or alterations to properties.

With the compact size of the skips, a smaller, lighter 3 ton vehicle is used to deliver & remove them which makes them very versatile in the removal of rubble from areas where a large truck has difficulty with access.

These skips can be very effective at sites such as small townhouses and shopping malls.

Mini Skip

